



VX-HDMI-4K-TX
VX-HDMI-4K-RX

MediaCento™ IPX 4K Transmitter and Receiver

Extend audio and video signals via an existing LAN.

Distribute HDMI video to an unlimited number of displays using IP multicast, or make eye-catching video walls of up to 9 x 9 displays.



**Customer
Support
Information**

Order toll-free in the U.S. or for FREE 24/7 technical support:
Call 877-877-BBOX (outside U.S. call 724-746-5500)
www.blackbox.com • info@blackbox.com

Trademarks Used in this Manual

Trademarks Used in this Manual

Black Box and the Double Diamond logo are registered trademarks, and MediaCento is a trademark, of BB Technologies, Inc.

Bonjour and Apple are registered trademarks of Apple, Inc.

Windows is a registered trademark of Microsoft Corporation.

UL is a registered trademark of Underwriters' Laboratories.

Any other trademarks mentioned in this manual are acknowledged to be the property of the trademark owners.

FCC and IC RFI Statement/NOM Statement

FEDERAL COMMUNICATIONS COMMISSION AND INDUSTRY CANADA RADIO FREQUENCY INTERFERENCE STATEMENTS

This equipment generates, uses, and can radiate radio-frequency energy, and if not installed and used properly, that is, in strict accordance with the manufacturer's instructions, may cause interference to radio communication. It has been tested and found to comply with the limits for a Class A computing device in accordance with the specifications in Subpart B of Part 15 of FCC rules, which are designed to provide reasonable protection against such interference when the equipment is operated in a commercial environment. Operation of this equipment in a residential area is likely to cause interference, in which case the user at his own expense will be required to take whatever measures may be necessary to correct the interference.

Changes or modifications not expressly approved by the party responsible for compliance could void the user's authority to operate the equipment.

This digital apparatus does not exceed the Class A limits for radio noise emission from digital apparatus set out in the Radio Interference Regulation of Industry Canada.

Le présent appareil numérique n'émet pas de bruits radioélectriques dépassant les limites applicables aux appareils numériques de classe A prescrites dans le Règlement sur le brouillage radioélectrique publié par Industrie Canada.

Normas Oficiales Mexicanas (NOM) Electrical Safety Statement INSTRUCCIONES DE SEGURIDAD

1. Todas las instrucciones de seguridad y operación deberán ser leídas antes de que el aparato eléctrico sea operado.
2. Las instrucciones de seguridad y operación deberán ser guardadas para referencia futura.
3. Todas las advertencias en el aparato eléctrico y en sus instrucciones de operación deben ser respetadas.

NOM Statement

4. Todas las instrucciones de operación y uso deben ser seguidas.
5. El aparato eléctrico no deberá ser usado cerca del agua—por ejemplo, cerca de la tina de baño, lavabo, sótano mojado o cerca de una alberca, etc.
6. El aparato eléctrico debe ser usado únicamente con carritos o pedestales que sean recomendados por el fabricante.
7. El aparato eléctrico debe ser montado a la pared o al techo sólo como sea recomendado por el fabricante.
8. Servicio—El usuario no debe intentar dar servicio al equipo eléctrico más allá a lo descrito en las instrucciones de operación. Todo otro servicio deberá ser referido a personal de servicio calificado.
9. El aparato eléctrico debe ser situado de tal manera que su posición no interfiera su uso. La colocación del aparato eléctrico sobre una cama, sofá, alfombra o superficie similar puede bloquea la ventilación, no se debe colocar en libreros o gabinetes que impidan el flujo de aire por los orificios de ventilación.
10. El equipo eléctrico debe ser situado fuera del alcance de fuentes de calor como radiadores, registros de calor, estufas u otros aparatos (incluyendo amplificadores) que producen calor.
11. El aparato eléctrico deberá ser conectado a una fuente de poder sólo del tipo descrito en el instructivo de operación, o como se indique en el aparato.
12. Precaución debe ser tomada de tal manera que la tierra física y la polarización del equipo no sea eliminada.
13. Los cables de la fuente de poder deben ser guiados de tal manera que no sean pisados ni pellizcados por objetos colocados sobre o contra ellos, poniendo particular atención a los contactos y receptáculos donde salen del aparato.
14. El equipo eléctrico debe ser limpiado únicamente de acuerdo a las recomendaciones del fabricante.
15. En caso de existir, una antena externa deberá ser localizada lejos de las líneas de energía.

16. El cable de corriente deberá ser desconectado del cuando el equipo no sea usado por un largo periodo de tiempo.
17. Cuidado debe ser tomado de tal manera que objetos líquidos no sean derramados sobre la cubierta u orificios de ventilación.
18. Servicio por personal calificado deberá ser provisto cuando:
 - A: El cable de poder o el contacto ha sido dañado; u
 - B: Objetos han caído o líquido ha sido derramado dentro del aparato; o
 - C: El aparato ha sido expuesto a la lluvia; o
 - D: El aparato parece no operar normalmente o muestra un cambio en su desempeño; o
 - E: El aparato ha sido tirado o su cubierta ha sido dañada.

Table of Contents

Table of Contents

1.	Specifications	8
2.	Overview	10
2.1	Introduction.....	10
2.2	Features.....	10
2.3	What's Included	11
2.4	Additional Items You Will Need	11
2.5	Hardware Description.....	12
2.5.1	Transmitter.....	12
2.5.2	Receiver	14
2.5.3	Indicators.....	16
2.5.4	Function Buttons (F1 and F2) and Reset Button	16
2.5.5	EDID Copy	17
3.	Installation	18
4.	Configuration.....	21
4.1	Connecting to the Devices	21
4.2	Connect to Web GUI Using the IP Address	21
4.3	Connect to Web GUI Using the Hostname.....	22
4.4	Network Information for Transmitter and Receiver	24
4.4.1	Transmitter.....	25
4.4.2	Receiver	28
5.	Video Wall	31
5.1	Application Diagram	31
5.2	Video Wall Setup.....	32
5.3	Bezel Compensation.....	33
6.	Accessing through Serial or Telnet.....	34
6.1	Accessing through Serial	34
6.2	Accessing through Telnet	35
7.	Command-Line Interface (CLI).....	36
7.1	Advanced IP Commands	37
7.2	Advanced Multicast IP Configuration	38
7.2.1	Transmitter.....	38
7.2.2	Receiver	39
7.3	Serial Extension	41
7.4	Telnet Extension	42

Table of Contents

8. Troubleshooting	44
8.1 Problems/Solutions.....	44
8.2 Contacting Black Box	45
8.3 Shipping and Packaging	45
Appendix: Connector Pinouts.....	46

Chapter 1: Specifications

1. Specifications

Technical Specifications

Approvals	FCC, TUV, CE, UL®, CSA, RoHS, WEEE
Control Method	Web (LAN), Serial, GUI, IR
Default IP Address	169.254.x.x <i>NOTE: To find the IP address of devices, simply connect to monitor devices, power up transmitter and receivers, and view IP addresses on the status screen.</i>
Distance	From CPU to TX: 16 ft. (5 m) maximum, HDMI; Between TX and RX: 328 ft. (100 m)* maximum <i>*NOTE: Use a network switch to get greater distances.</i>
HDCP	2.2 and 1.4
Latency	2 frames (33 ms) maximum
Leads Supported	HDMI video and RS-232
User Controls	Each unit (transmitter or receiver): (1) 16-position rotary selection switch, (2) Function buttons: (1) F1, (1) F2
Video Resolution (Max.)	4K UHD (3840 x 2160) @ 30 Hz
Connectors	Transmitter: (1) Locking HDMI female, (1) RJ-45 interconnect/LAN connection, (2) 3.5-mm audio jacks: (1) IN, (1) OUT, (1) 2.1-mm barrel connector for power, (1) Type B USB, (2) RJ-12 6P6C+; (2) 3.5-mm IR ports (1) IN, (1) OUT; <i>†NOTE: Only 4 center pins are used at this time.</i>

Technical Specifications (continued)

Connectors (continued)	<p>Receiver:</p> <ul style="list-style-type: none"> (1) Locking HDMI female, (1) RJ-45 interconnect/LAN connection, (2) 3.5-mm audio jacks: (1) IN, (1) OUT, (1) 2.1-mm barrel connector for power, (4) USB Type A, (2) RJ-12 6P6C†, (2) 3.5-mm IR ports (1) IN, (1) OUT; <p><i>†NOTE: Only 4 center pins are used at this time.</i></p>
Indicators	<ul style="list-style-type: none"> (1) LED for Power/Link; (1) LED for Network Status
Environmental	<p>Temperature Tolerance:</p> <ul style="list-style-type: none"> Operating: 32 to 104° F (0 to 40° C); Storage: -4 to +140° F (-20 to +60° C) <p>Humidity Tolerance: Operating: 80%, noncondensing;</p> <p>Altitude: 10,000 ft. (3048 m) maximum</p>
Power	<p>Input: 100–240 VAC, 50/60 Hz, 0.6 A;</p> <p>Output: 9–12 VDC, 1.5 A;</p> <p>Consumption: 13.5 W (each unit);</p> <p>Power Supply Cord Length: 6 ft. (1.8 m)</p>
Power over Ethernet (PoE)	<p>Complies with IEEE 802.3af standard;</p> <p>Power: Nominal Input: 48 VDC;</p> <p>Input Range: 36–57 VDC</p>
Size	<p>Each unit:</p> <p style="padding-left: 20px;">1.1"H x 4.6"W x 5.9"D (2.8 x 11.7 x 15 cm)</p>
Weight	<p>Each unit:: 1.43 lb. (0.65 kg);</p>

Chapter 2: Overview

2. Overview

2.1 Introduction

The MediaCento IPX 4K is a perfect solution for audio and video signal extension via an existing Local Area Network (LAN) system.

In a unicast configuration, the MediaCento transmitter and receiver pair is ideal for 4K UHD video signal extension via an existing LAN.

In a multicast configuration, one local unit can drive multiple remote units with no extra network load. There are 16 selectable channels that can be used to transmit to multiple receivers. In a network that supports IGMP, each channel can connect to unlimited displays in video wall applications and unlimited displays in a multicast application using a standard IT Ethernet structure on a LAN system. For each source device, a transmitter is required, and a receiver is needed for each display device.

The MediaCento IPX 4K supports 4K UHD and Full HD 1080p, is HDCP compliant and supports Power over Ethernet (PoE). It can handle applications that require greater distance, high speed transmission, real-time high video resolution, security, and noise immunity. It is ideal for situations that need live presentation, such as public broadcasting, education centers, boardrooms, etc.

2.2 Features

- Extend 4K UHD video, audio signals, IR, RS-232 and USB signals over a LAN.
- Power over Ethernet:
 - Fully support IEEE Std. 802.3af-2003
 - Input Voltage Range 36V to 57V
- Choose from 16 selections on the DIP rotary switch for pairing.
- Provide automatic EDID configuration.
- Use well-developed Ethernet technology and TCP/IP communication protocol.
- Transmitters and Receivers are HDCP-compliant and Blu-ray ready.
- HDTV compatible; support 4K UHD 3840 x 2160 @ 30 Hz, 1080p, 1080i, 720p, 720i.
- Compatible with popular screen resolutions: XGA, SXGA, UXGA, WSXGA...full HD system.
- Analog audio embedding and extraction.
- Built-in video wall support.

- Built-in downscaling. 4K to 1080p compatibility with older displays.
- Each transmitter can be multicast to up to an unlimited number of displays in video wall applications or unlimited displays in multicast applications.
- Use an IGMP network to prevent network flooding.
- Optional wall mounting bracket.
- PoE function supported: no additional power supply required for either the transmitter or receiver end.

When used in a video wall application, the extenders:

- Assign video sources to any monitors on the video wall.
- Support 2x2, 3x3, 4x4...8x8, 9x9 screen array. The maximum is 9x9.
- Provide several cutting modes for 1xN (1x2, 1x3...), 2x3, 2x4, up to a maximum of 8x16 for a wide variety of applications, including commercial office buildings, exhibition halls, and interactive digital signage.

2.3 What's Included

- MediaCento IPX 4K Transmitter (VX-HDMI-4K-TX) or MediaCento IPX 4K Receiver (VX-HDMI-4K-RX)
- (1) U.S. power supply
- (1) U.S. power cord
- (4) foot pads
- This user manual

VX-HDMI-4K-TX also has:

- (1) MediaCento IPX 4K Transmitter
- (1) DB9 F to RJ-11 adapter
- (1) RJ-11 to RJ-11 cable

VX-HDMI-4K-RX also has:

- (1) MediaCento IPX 4K Receiver

2.4 Additional Items You Will Need

- HDCP-compliant monitors with HDMI interface for the HDCP video source
- CAT5/5e/6 UTP cable (EIA/TIA 568B industry-standard compliant)
- Layer 2 or 3 switches with IGMP and optional Power over Ethernet (PoE)

Chapter 2: Overview

2.5 Hardware Description

2.5.1 Transmitter

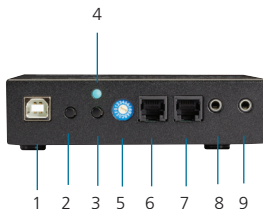

Figure 2-1. Transmitter front panel.

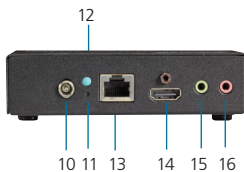

Figure 2-2. Transmitter back panel.



Figure 2-3. Transmitter top panel.

Table 2-1. Components of the Transmitters.

Number	Component	Description
1	Type B USB connector	Connect to a PC
2	F2 button	See Section 2.6.4.
3	F1 button	See Section 2.6.4.
4	Power/Link LED	Green: Power ON Interlaced flashing Blue + Green: Link w/o video source input Blue: Link OK
5	ID (Rotary switch)	Set up an identical position for all units
6	RJ-12 connector	Serial port 1: For system control
7	RJ-12 connector	Serial port 2: For data communication
8, 9	(2) 3.5-mm IR connectors	IR emitter and receiver connectors
10	Locking barrel connector for power	Links to power supply (not required with PoE switch)
11	Reset button	System reset
12	Network Status LED	Flashing: Connected to network Goes off once: Abnormal
13	RJ-45 jack	Connects to the 10-/100-/1000-Mbps network switch and supplies PoE
14	Locking Video connector	Connects to an HDMI source
15, 16	(2) 3.5-mm Audio jacks	Line IN and OUT for microphone and audio connections

2.5.2 Receiver

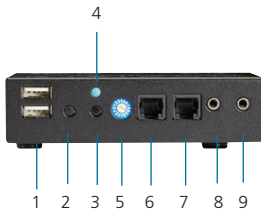

Figure 2-4. Receiver front panel.

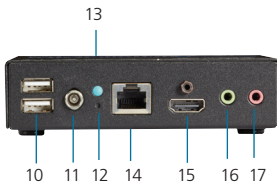

Figure 2-5. Receiver back panel.



Figure 2-6. Receiver top panel.

Table 2-2. Components of the Receivers.

Number	Component	Description
1	(4) Type A USB connectors	Connect to USB 2.0 devices
2	F2 button	See Section 2.6.4.
3	F1 button	See Section 2.6.4.
4	Power/Link LED	Red: Power OFF Interlaced flashing Blue + Red: Link without video source input Blue: Link OK
5	ID (Rotary switch)	Set up an identical position for all units
6	RJ-12 connector	Serial port 1: For system control
7	RJ-12 connector	Serial port 2: For data communication
8, 9	(2) 3.5-mm IR connectors	IR emitter and receiver connectors
10	(2) Type B USB connectors	Connect to USB 2.0 devices
11	Locking barrel connector for power	Links to power supply (not required with PoE switch)
12	Reset button	System reset
13	Network Status LED	Flashing: Connected to network Goes off once: Abnormal
14	RJ-45 jack	Connects to the 10-/100-/1000-Mbps network switch and supplies PoE
15	Locking Video connector	Connects to HDMI monitor
16, 17	(2) 3.5-mm Audio jacks	Connect to a speaker IN/OUT.

Chapter 2: Overview

2.5.3 Indicators

The LEDs on the extender units show the real-time status indicating the linking and communication between the Transmitter/Sender unit and the Receiver unit. Users can identify the current status through the LED indicators on the unit.

NOTE: The system will disable the video output signal when it detects non-HDCP-compliant display(s) trying to play on the HDCP video source. All the connected output displays MUST be HDCP compliant when the video source is HDCP compliant.

2.5.4 Function Buttons (F1 and F2) and Reset Button

The Function buttons (F1 and F2) on the extender units operate as described in Table 2-3.

Table 2-3. Function buttons.

Button	Action	Description
F2	Press for 1 second.	Toggle between graphics and video mode.
F2	<ol style="list-style-type: none">1. Press and hold the F2 button.2. Apply power to the receiver unit.3. Release right after the Network Status LED starts blinking.	EDID copy (Receiver unit only!)
F2	Press for 5 seconds.	Change anti-dithering mode
F1	Press for 1 second.	Link/Unlink connection

Table 2-3. Function buttons (continued).

Button	Action	Description
F1	<ol style="list-style-type: none">1. Press and hold the F1 button.2. Apply power to the unit.3. Release right after the Network Status LED starts blinking.4. Power cycle the unit.	Resets the box to factory defaults.
Reset	Press and hold the Reset button.	Reboot the system

2.5.5 EDID Auto Copy (on Receiver Unit only)

Copying the EDID will enable the source to send correct resolutions to your display. Although the default EDID will work in most cases, some monitors will not work with it. When enabled, EDID will be copied automatically upon connection to a new display.

EDID Auto copy is enabled in unicast applications by default. Performing this procedure is equivalent to enabling EDID auto copy in the Web GUI.

NOTE: EDID copy is recommended for use with DVI monitors.

To enable autocopy of EDID:

1. To copy EDID from a specific receiver to a specific transmitter, both receiver and transmitter must be configured to the same channel.
2. Hold down the function button on the receiver and plug in the power.
3. Continue to hold down the function button until the network LED starts blinking. EDID is now copied to the receiver.

You can also disable EDID copy through the Web GUI.

Chapter 3: Installation

3. Installation

WARNINGS:

Make sure that all devices are powered off before connecting to the unit.

Make sure all devices you will connect are properly grounded.

Place cables away from fluorescent lights, air conditioners, and machines.

Allow adequate space around the unit for air circulation.

System Requirements for PoE

1. Make sure that a PSE device supports PoE function.
2. Make sure that a PSE device can provide sufficient power on the Ethernet cable.
3. We recommend that you use STP and FTP cabling.

3.1 Installation Steps

NOTE: The extenders are configured as multicast units by default. To use the extenders in a plug-and-play unicast configuration, you must change the default configuration. See Chapter 4, Configuration, for details.

1. Connect the video source to the transmitter unit.
2. Connect the monitor to the receiver unit.
3. Use CAT5 cables to connect transmitter/receiver to LAN hub.
4. Set an identical ID number on the rotary DIP switch for both transmitter and receiver.
5. Apply the power to all connected devices (if you are not using a PoE switch).

NOTES:

- A. *We recommend that you use a Gigabit switch for optimum transmission quality.*
- B. *If users cannot see the screen display on their computer connection, see Section 7.1 of this manual.*

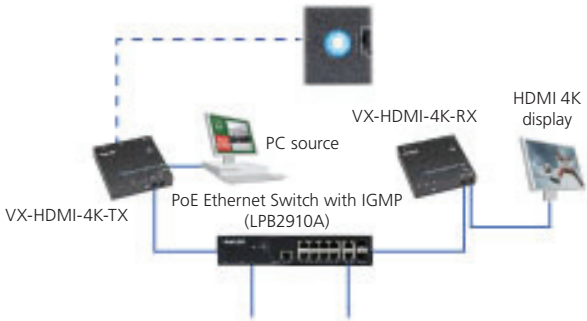

Figure 3-1. Connection pattern for unicast configuration with an Ethernet switch.

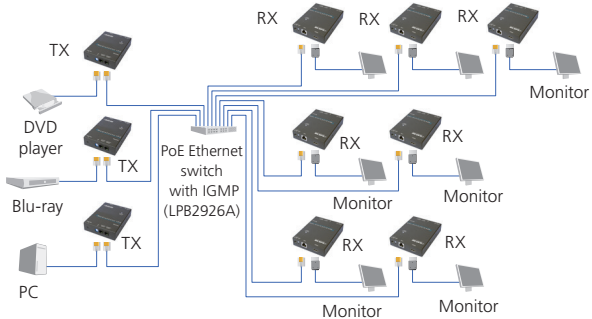

Figure 3-2. Multicast configuration.

Chapter 3: Installation

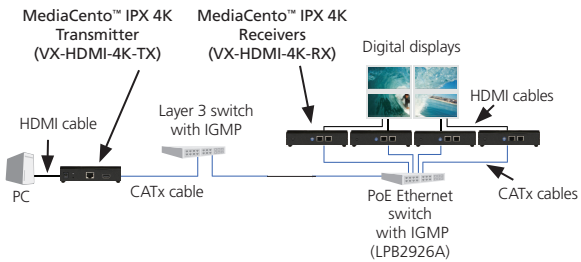

Figure 3-3. Video Wall configuration.

4. Configuration

4.1 Connecting to the Devices

You can access devices through the Web GUI, serial interface, or Telnet for advanced configuration of network and video settings. See Chapter 6 for telnet and serial connection.

4.2 Connect to Web GUI Using the IP Address

To see the IP address of a receiver:

Connect receiver and transmitter to a network switch or directly with a cable. Make sure they are set to the same channel. Next, connect a receiver to a monitor and power on. Device information, including the IP address, will be in the lower right corner. After booting, the receiver will briefly show the status screen before connecting to the transmitter.

Push the F1 button on the receiver and the video will stop and you can see the IP of both the transmitter and receiver.



Figure 4-1. IP of transmitter and receiver shown on screen.

1. Configure the control PC's network setting as 169.254.xxx.xxx IP domain with netmask 255.255.0.0.
2. Open a Web browser, click on the Network tab, and insert the IP address of the device.

Chapter 4: Configuration

4.3 Connect to Web GUI Using the Host name

Bonjour® is needed to access the Web interface by the hostname. Apple® products usually have this installed. If needed, you can download the free version from apple.com.

1. Run Bonjour.
2. Configure the control PC's network setting as 169.254.xxx.xxx IP domain with netmask 255.255.0.0. Default gateway and DNS can be left blank.
3. Open a Web browser and insert the address: `http://ast-gatewayXXXX.local`. The four digits after `ast-gateway` depend on the position of the Rotary Switch you've set. Please refer to Table 4-1. For example, if the position is set up as 7, then the address should be `http://ast-gateway1110.local`

Table 4-1. Channel listing for unicast address.

Rotary Switch	Four Digits	Domain Name
0	0000	http://ast-gateway0000.local
1	1000	http://ast-gateway1000.local
2	0100	http://ast-gateway0100.local
3	1100	http://ast-gateway1100.local
4	0010	http://ast-gateway0010.local
5	1010	http://ast-gateway1010.local
6	0110	http://ast-gateway0110.local
7	1110	http://ast-gateway1110.local
8	0001	http://ast-gateway0001.local
9	1001	http://ast-gateway1001.local
A	0101	http://ast-gateway0101.local
B	1101	http://ast-gateway1101.local
C	0011	http://ast-gateway0011.local
D	1011	http://ast-gateway1011.local
E	0111	http://ast-gateway0111.local
F	1111	http://ast-gateway1111.local

Chapter 4: Configuration

4.4 Network Information for Transmitter and Receiver

- IP Mode – Auto IP, DHCP, Static
- Auto IP (default) – Uses Zero Conf to find an open IP address in the 169.254.x.x range.
- DHCP – Assign an IP address through DHCP.
- Static – Specify an IP address, netmask, and gateway.
- Subnet mask — Default value: 255.255.0.0
- Default Gateway – Default value: 169.254.0.254

Casting mode – Multicast/Unicast

- Multicast (default) – Uses Multicasting technology to transport one video stream to multiple receivers
- Unicast – Does not use multicasting, only a single receiver will be connected to a transmitter for point to point over IP

The screenshot shows a web-based configuration interface with a blue header bar containing tabs for 'System', 'Video Wall', 'Network', and 'Functions'. The 'Network' tab is active. Below the header, the 'IP Setup' section is displayed. It features three radio buttons for 'IP Mode': 'Auto IP' (selected), 'DHCP', and 'Static'. Below these are three input fields: 'IP Address' (169.254.9.12), 'Subnet Mask' (255.255.0.0), and 'Default Gateway' (169.254.0.254). An 'Apply' button is located at the bottom right of this section. The 'Casting Mode' section below it has two radio buttons: 'Multicast' (selected) and 'Unicast'. There is also a checkbox labeled 'Auto select USB operation mode per casting mode (recommended)' which is currently unchecked. An 'Apply' button is also present at the bottom right of the Casting Mode section.

Figure 4-2. IP setup screen for transmitter and receiver.

4.4.1 Transmitter

Video over IP:

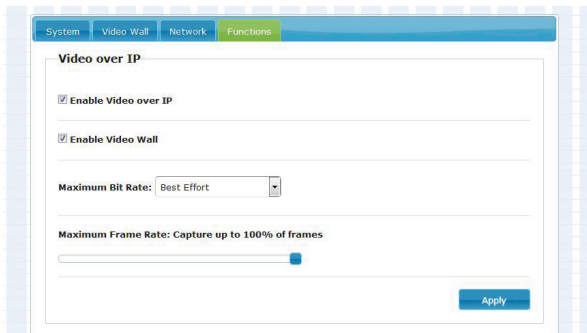

Figure 4-3. Video over IP screen for transmitter.

1. Click on the Functions tab.
2. Check the box next to Enable Video over IP.
3. Check the box next to Enable Video Wall.
4. From the drop-down menu, select the Maximum Bit Rate. Options include Best Effort, 200 Mbps, 150 Mbps, 100 Mbps, 50 Mbps, and 10 Mbps.
5. Using the slider bar, select the Maximum Frame Rate. Values range from 2–100%.

Chapter 4: Configuration

USB over IP:

USB over IP

Enable USB over IP

Operation Mode:

Auto select mode (Recommended, choose per network casting mode)

Active on link (Unicast network's default mode)

Active per request (Multicast network's default mode)

Compatibility Mode:

Mouse not responding well (Check when USB mouse responding is slow and queer)

K/M over IP (Uncheck when mouse/keyboard/touch panel not working as expected)

Apply

Figure 4-4. USB over IP screen for Transmitter.

1. Check the box next to Enable USB over IP.
2. Select the Operation Mode by clicking on the radio button. Options include:
 - Auto select mode (Recommended, choose per network casting mode)
 - Active on link (Unicast network's default mode)
 - Active per request (Multicast network's default mode)
3. Check the box next to Compatibility Mode. Choose from:
 - Mouse not responding well (Check when USB mouse responding is slow)
 - K/M over IP (Uncheck when mouse/keyboard/touch panel is not working as expected)

Serial over IP:

Serial over IP

Enable Serial over IP

Operation Mode:

Type 1 (Need extra control instruction. For advanced usage.)

Type 2 (Recommended. Dumb redirection.)

Type 1 guest mode

Type 2 guest mode

Baudrate Setting for Type 2:

Baudrate: 115200

Data bits: 8

Parity: None

Stop bits: 1

Apply

Figure 4-5. Serial over IP for transmitter.

1. Check the box next to Enable Serial over IP.
2. Select the Operation Mode from the four radio buttons:
 - Type 1 (Need extra control instructions. For advanced usage.)
 - Type 2 (Recommended. Dumb redirection.)
 - Type 1 guest mode
 - Type 2 guest mode

NOTE: See Sections 6.1 for telnet extension and 6.2 for serial extension details.

3. Select the Baudrate setting from the drop-down box:

Here, we chose Baudrate Setting for Type 2.

Select the serial parameters from the drop-down boxes.

- Baudrate
- Data Bits
- Parity
- Stop Bits

Chapter 4: Configuration

4.4.2 Receiver

Video Over IP:

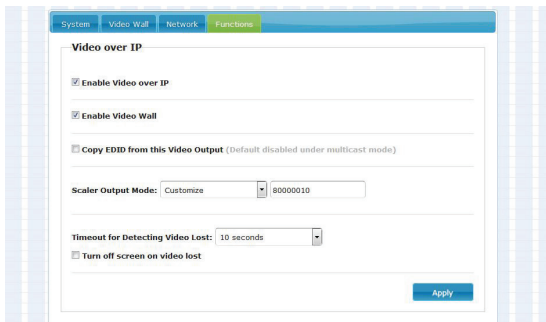

Figure 4-6. Video over IP for receiver.

1. Click on the Functions tab.
2. Check the box next to Enable Video over IP.
3. Check the box next to Enable Video Wall.
4. For multicast mode, leave the box unchecked next to Copy EDID from this Video Output (Default disabled under multicast mode).
5. From the drop-down menu, select the Scaler Output Mode. Options include:
 - Pass-Through
 - Full HD 1080p60
 - Full HD 1080p50
 - Ultra HD 2160p30
 - Ultra HD 2160p25
 - Customize

When you select “Customize,” you will see an empty text box. Type in your Custom setting.

- From the drop-down menu, select the Timeout for Detecting Video Lost. Options include: 3 seconds, 5 seconds, 10 seconds, 20 seconds, 30 seconds, 60 seconds, and Never Timeout.
- Check the box next to Turn off screen on video lost if you want the screen to turn off when video is lost. If not, keep the box unchecked.

USB over IP:

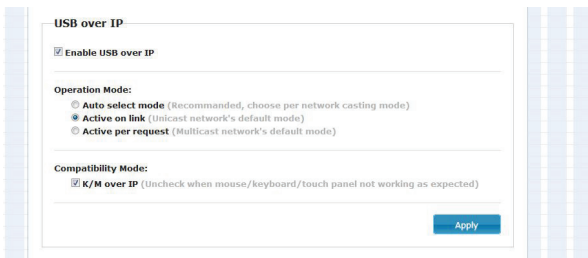

The screenshot shows a configuration window titled "USB over IP". It contains the following settings:

- Enable USB over IP**
- Operation Mode:**
 - Auto select mode** (Recommended, choose per network casting mode)
 - Active on link** (Unicast network's default mode)
 - Active per request** (Multicast network's default mode)
- Compatibility Mode:**
 - K/M over IP** (Uncheck when mouse/keyboard/touch panel not working as expected)

An "Apply" button is located at the bottom right of the configuration area.

Figure 4-7. USB over IP for receiver.

- Check the box next to Enable USB over IP.
- Select the Operation Mode from the three radio buttons:
 - Auto select mode (Recommended, choose per network casting mode)
 - Active on link (Unicast network's default mode)
 - Active per request (Multicast network's default mode)
- Check/uncheck the box to select/de-select the Compatibility Mode.
 - K/M over IP (Uncheck when mouse/keyboard/touch panel not working as expected)

Chapter 4: Configuration

Serial over IP:

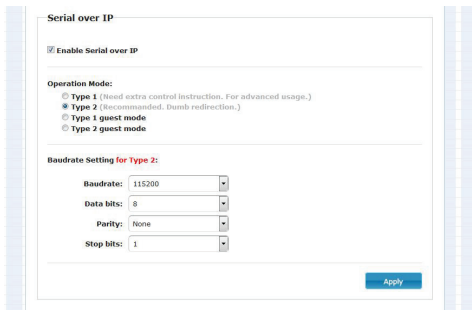

The screenshot shows a configuration window titled "Serial over IP". At the top, there is a checkbox labeled "Enable Serial over IP" which is checked. Below this is a section for "Operation Mode" with four radio button options: "Type 1 (Need extra control instruction. For advanced usage.)", "Type 2 (Recommended. Dumb redirection.)" (which is selected), "Type 1 guest mode", and "Type 2 guest mode". Underneath is a section titled "Baudrate Setting for Type 2:" containing four dropdown menus: "Baudrate" (set to 115200), "Data bits" (set to 8), "Parity" (set to None), and "Stop bits" (set to 1). An "Apply" button is located in the bottom right corner of the configuration area.

Figure 4-8. Serial over IP for receiver.

1. Check the box next to Enable Serial over IP.
2. Select the Operation Mode from the four radio buttons:
 - Type 1 (Need extra control instructions. For advanced usage.)
 - Type 2 (Recommended. Dumb redirection.)
 - Type 1 guest mode
 - Type 2 guest mode

NOTE: See Sections 6.1 for telnet extension and 6.2 for serial extension details.

3. Select the serial parameters from the drop-down boxes:

Here, we show Baudrate Setting for Type 2.

- Baudrate
- Data Bits
- Parity
- Stop Bits

5. Video Wall

5.1 Application Diagram

Using the Video Wall features, you can send video and audio to unlimited outputs through IP. Format the video wall so that separate sections of the video can be sent to different outputs. Basic settings allow for bezel compensation and different arrays of screens. Advanced settings allow for video manipulation to specific outputs. Figure 7-1 shows a typical application:

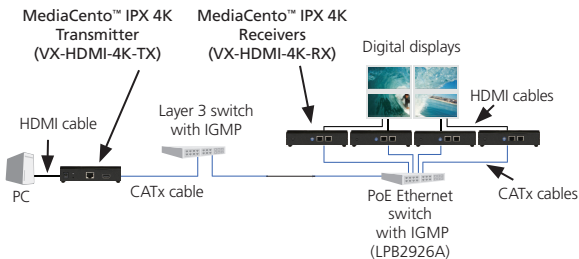

Figure 5-1. Sample installation.

Chapter 5: Video Wall

5.2 Video Wall Setup

Step 1: Use the show OSD button to display the IP/Name of your receiver units. Select "All" from the Apply To drop down box and check the Show OSD check box. Click Apply to display the OSD on the displays connected to receivers. This information will be used in determining position of each receiver in the video wall.

Step 2: Select each individual receiver one at a time that will be in the video wall. You can do this by using the drop-down box under Apply To.

Step 3: Select the dimensions of your video wall using the Vertical Monitor Count and Horizontal Monitor Count drop-down boxes.

Wall Size and Position Layout

Vertical Monitor Count: 1

Horizontal Monitor Count: 1

Row Position: 0

Column Position: 0

UNIT: Panel

Preferences

Stretch Type: Fit In

Clockwise Rotate: 0

Apply To: "All" device(s) in the list

All [Apply]

Show OSD

Figure 5-2. Wall size and position layout screen.

Step 4: Using information gained from the OSD, adjust the Row Position and Column Position of your receiver. Position (0,0) is the top left corner of the video wall.

Step 5: Repeat this process for each receiver in the video wall

5.3 Bezel Compensation

Measurements of the display will need to be taken to set up bezel compensation. Measuring units (inch, cm, mm) do not matter, but the same unit should be used for all measurements.

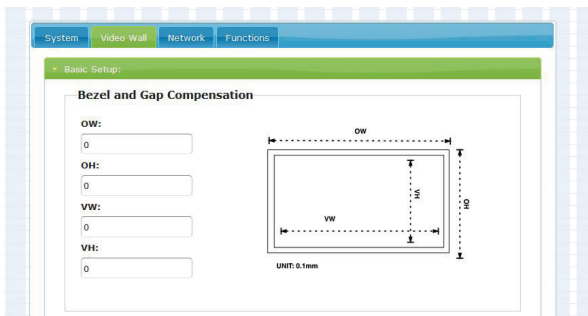

Figure 5-3. Wall size and position layout screen.

Step 1: Measure the outer dimensions of the display (edge to edge including bezel). Enter the width of the display in the OW textbox. Enter the height of the display in the OH textbox.

Step 2: Measure the inner dimensions of the display (This is actual screen size, not including the bezel). Enter the width of the screen in the VW textbox. Enter the height of the screen in the VH textbox.

Chapter 6: Accessing through Serial or Telnet

6. Accessing through Serial or Telnet

6.1 Accessing through Serial

1. Using the client, select “serial” and enter “115200” for the speed (baud rate).

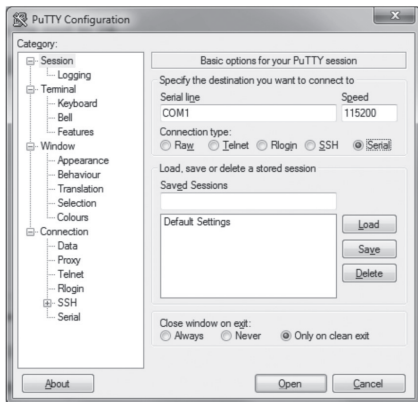

Figure 6-1. PuTTY configuration screen using serial.

2. No username or password is required. Just press enter.

6.2 Accessing through Telnet

1. Using the client, enter in the IP address of the device.
2. Change the port to 24.

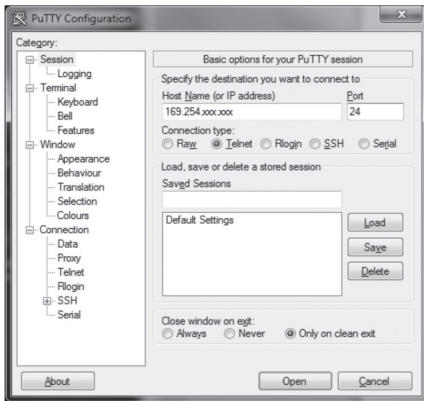

Figure 6-2. PuTTY configuration screen using Telnet.

3. The default password is root.

Chapter 7: Command-Line Interface

7. Command-Line Interface (CLI)

These are advanced configurations and require knowledge of IP networking protocols and multicasting. Do not attempt to run any commands, modify files, or change any other settings apart from the specific configurations noted here.

All commands are case-sensitive.

To list names and IP information of all connected MediaCento IPX devices, type in:
node_list

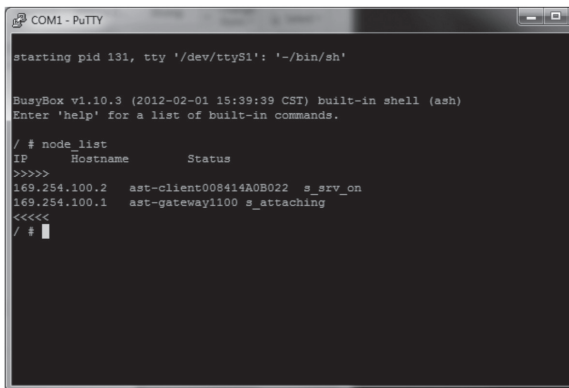

```
COM1 - PuTTY
starting pid 131, tty '/dev/ttyS1': '-/bin/sh'
BusyBox v1.10.3 (2012-02-01 15:39:39 CST) built-in shell (ash)
Enter 'help' for a list of built-in commands.

/ # node_list
IP      Hostname      Status
>>>>>
169.254.100.2  ast-client008414A0B022  s_srv_on
169.254.100.1  ast-gateway1100  s_attaching
<<<<<
/ # █
```

Figure 7-1. Names and IP information list.

To view all current configured parameters, type in:

astparam dump

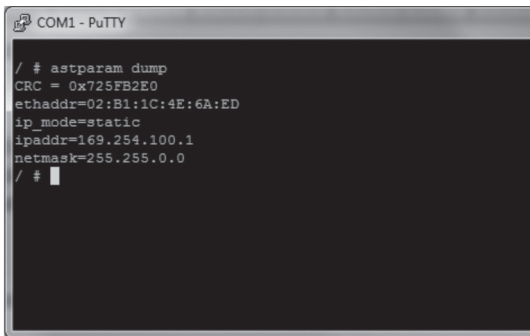

```
COM1 - PuTTY
/ # astparam dump
CRC = 0x725FB2E0
ethaddr=02:B1:1C:4E:6A:ED
ip_mode=static
ipaddr=169.254.100.1
netmask=255.255.0.0
/ #
```

Figure 7-2. Current configured parameters list.

To reset to factory default, setting the IP mode to autoip and removing any overrides, type in:

```
reset_to_default.sh
```

To change the baud rate of the serial extension interface, type in:

```
stty X -F /dev/ttyS0
```

(replace X with desired baud rate)

To disable/enable the link for a specific device, type in:

```
ast_send_event -1 e_stop_link
```

```
ast_send_event -1 e_reconnect
```

7.1 Advanced IP Commands

Each device has three possible modes of establishing an IP address: autoip, dhcp, and static.

1. AutoIP is the default mode and it will always automatically assign available IP addresses in the private IP domain 169.254.xxx.xxx

NOTE: The MediaCentO IPX uses the Avahi zeroconf protocol to find an available IP in the 169.254.xxx.xxx range.

Chapter 7: Command-Line Interface

2. DHCP client gets an address from the local DHCP server.

CAUTION: Make sure a DHCP client is connected or problems will occur.

3. Static allows you to manually change the IP address and netmask of the device.
This requires further input before reboot.

To change the IP mode, type in:

```
astparam s ip_mode <mode>          (where <mode> is autoip, dhcp, or static)
astparam save                        (saves changes)
reboot                               (reboots the device)
```

If static is selected, the following commands are needed before reboot. Type in:

```
astparam s ipaddr xxx.xxx.xxx.xxx   (enter IP address for x's)
astparam s netmask xxx.xxx.xxx.xxx  (enter netmask for x's)
astparam save                       (saves changes)
reboot
```

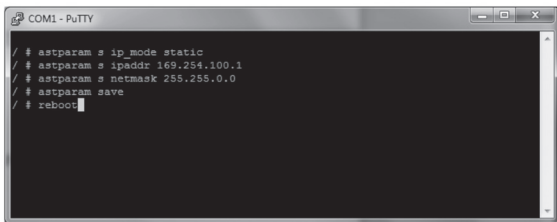

Figure 7-3. COM1 PuTTY screen.

7.2 Advanced Multicast IP Configuration

Predefined multicast addresses can be selected by using the rotary switch buttons on the devices (recommended). See Table 7-1 for listing of channels.

7.2.1 Transmitter

To change the multicast group IP, type in:

```
astparam s multicast_ip 225.0.B0.B1B2B3
```

To change the hostname ID of the transmitter, type in:

```
astparam s hostname_id B0B1B2B3
ast_send_event -1 e_chg_hostname
```

To override DIP rotary switch setting on bootup:

```
astparam s reset_ch_on_boot n      (space between boot and the n)
    astparam save
    reboot
```

7.2.2 Receiver

To change the multicast group IP, type in:

```
astparam s multicast_ip 225.0.B0.B1B2B3
```

To change the transmitter channel read:

```
astparam s ch_select B0B1B2B3
```

To override DIP rotary switch setting on bootup, type in:

```
astparam s reset_ch_on_boot n      (space between boot and the n)
astparam save
reboot
```

Table 7-1. Channel listing for multicast address.

Channel IDs	Multicast Address
0	225.0.100.0
1	225.0.100.1
2	225.0.100.8
3	225.0.100.9
4	225.0.100.100
5	225.0.100.101
6	225.0.100.110
7	225.0.100.111
8	225.0.101.0
9	225.0.101.1
A	225.0.101.8
B	225.0.101.9
C	225.0.101.100
D	225.0.101.101
E	225.0.101.110
F	225.0.101.111

7.3 Serial Extension

Serial extension can be done from one transmitter to all linked receivers. Telnet serial extension is also available as a replacement of serial. Serial extension information:

Default baud rate: 9600 (unless changed manually)

Data bits: 8

Parity: Even

Stop bits: 1

Flow control: None

NOTE: This is a two-way communication. The transmitter will receive any data sent from the serial devices connected to the receivers.

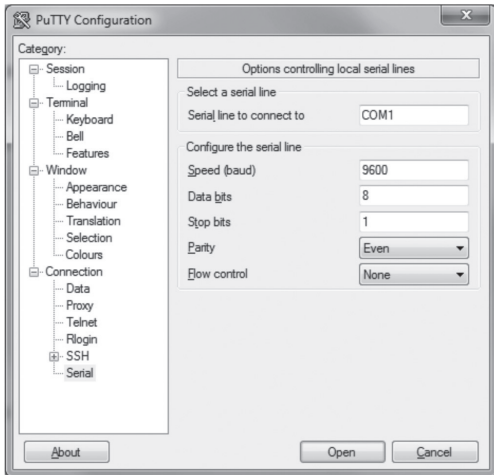

Figure 7-4. Options controlling local serial lines.

Chapter 7: Command-Line Interface

For both transmitter and receiver units, the added RJ-11 to DB9 serial cable needs to be connected to the second serial port on the devices.

7.4 Telnet Extension

Telnet serial extension allows for serial output from a receiver through a Telnet connection. This disables serial input coming from a transmitter but allows for 2-way communication to specific devices.

NOTE: Telnet extension needs serial extension setting changed to "Type 2 guest mode" in the Web interface. For details, contact Black Box Technical Support at 724-746-5500 or info@blackbox.com.

To set up a Telnet extension:

1. Using a Telnet protocol, use Port 6752.

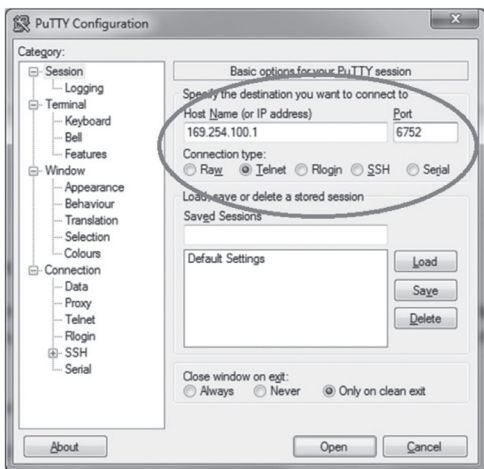

Figure 7-5. Setting up Telnet extension using a Telnet protocol.

2. Turn off line echo and local line editing.

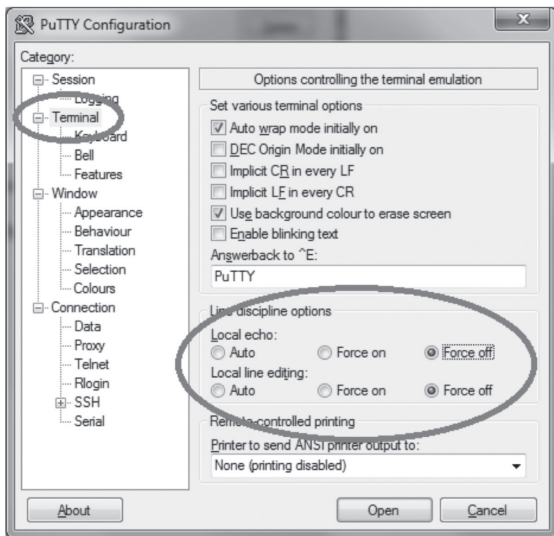

Figure 7-6. Turning off line echo and local line editing.

Chapter 8: Troubleshooting

8. Troubleshooting

8.1 Problem/Solutions

Problem: No video on monitor at bootup.

Solutions:

1. Check the device power using the Link/Power LED.
2. Check the network connection using the Network LED.
3. Check the video connection using the Link/Power LED.
4. Make sure that the DIP rotary switch is set to the correct ID.

NOTE: If manually changed, make sure the IDs match.

5. If you're using a mix of multicast and unicast units, make sure they match up correctly.
6. Set your display device's (TV, monitor, etc.) input source as HDMI.
7. Check the PC BIOS configuration for the video output setting.
8. Connect your computer to the HDMI Display DIRECTLY to check if the video signal gets through.
9. Make sure the DVI monitor is using the correct EDID. See Section 2.6.5 for details.
10. Verify that displays are HDCP compliant if copy protected content is being transmitted.

Problem: Video is of lower quality than input video.

Solutions:

1. Check that network settings are configured correctly.
2. Check if anti-dithering is turned off.

8.2 Contacting Black Box

If you determine that your MediaCentro IPX with PoE is malfunctioning, do not attempt to alter or repair the unit. It contains no user-serviceable parts. Contact Black Box Technical Support at 877-877-2269 or info@blackbox.com.

Before you do, make a record of the history of the problem. We will be able to provide more efficient and accurate assistance if you have a complete description, including:

- the nature and duration of the problem.
- when the problem occurs.
- the components involved in the problem.
- any particular application that, when used, appears to create the problem or make it worse.

8.3 Shipping and Packaging

If you need to transport or ship your MediaCentro IPX with PoE:

- Package it carefully. We recommend that you use the original container.
- If you are returning the unit, make sure you include everything you received with it. Before you ship for return or repair, contact Black Box to get a Return Authorization (RA) number.

Appendix: Connector Pinouts

Appendix. Connector Pinouts

Figure A-1 shows the DB9 to RJ-12 or RJ-11 connector pinouts.

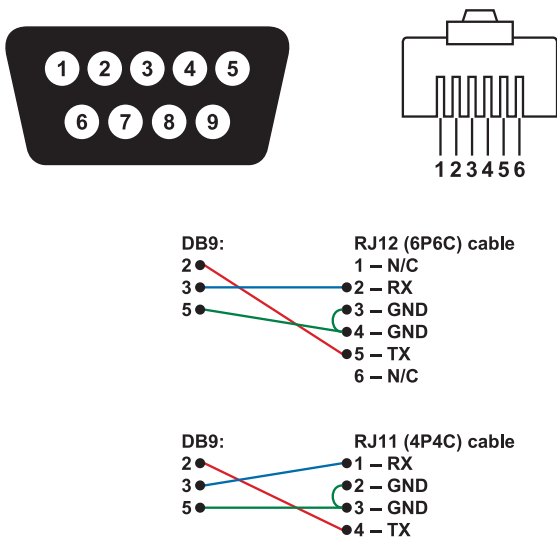
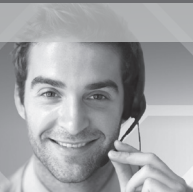

Figure A-1. DB9 to RJ-12 6P6C or RJ-11 (4P4C) cable pinout.

Black Box Tech Support: FREE! Live. 24/7.

Tech support the
way it should be.



Great tech support is just 60 seconds away
at 877-877-2269 or blackbox.com.



About Black Box

Black Box provides an extensive range of networking and infrastructure products. You'll find everything from cabinets and racks and power and surge protection products to media converters and Ethernet switches all supported by free, live 24/7 Tech Support available in 60 seconds or less.

© Copyright 2016. Black Box Corporation. All rights reserved..

VX-HDMI-4K-TX_RX_version 1

877-877-2269 | blackbox.com